

LMH6321 300 mA High Speed Buffer with Adjustable Current Limit

Check for Samples: [LMH6321](#)

FEATURES

- High Slew Rate 1800 V/ μ s
- Wide Bandwidth 110 MHz
- Continuous Output Current \pm 300 mA
- Output Current Limit Tolerance \pm 5 mA \pm 5%
- Wide Supply Voltage Range 5V to \pm 15V
- Wide Temperature Range -40°C to $+125^{\circ}\text{C}$
- Adjustable Current Limit
- High Capacitive Load Drive
- Thermal Shutdown Error Flag

APPLICATIONS

- Line Driver
- Pin Driver
- Sonar Driver
- Motor Control

DESCRIPTION

The LMH6321 is a high speed unity gain buffer that slews at 1800 V/ μ s and has a small signal bandwidth of 110 MHz while driving a 50 Ω load. It can drive \pm 300 mA continuously and will not oscillate while driving large capacitive loads.

The LMH6321 features an adjustable current limit. The current limit is continuously adjustable from 10 mA to 300 mA with a \pm 5 mA \pm 5% accuracy. The current limit is set by adjusting an external reference current with a resistor. The current can be easily and instantly adjusted, as needed by connecting the resistor to a DAC to form the reference current. The sourcing and sinking currents share the same current limit.

The LMH6321 is available in a space saving 8-pin SO PowerPAD or a 7-pin DDPACK power package. The SO PowerPAD package features an exposed pad on the bottom of the package to increase its heat sinking capability. The LMH6321 can be used within the feedback loop of an operational amplifier to boost the current output or as a stand alone buffer.

CONNECTION DIAGRAM

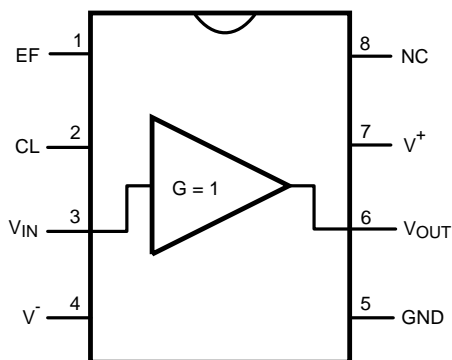
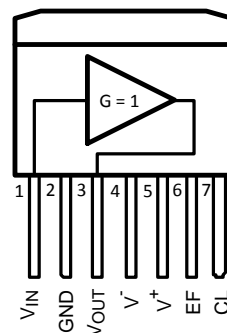
Figure 1. 8-Pin SO PowerPAD

A. V⁻ pin is connected to tab on back of each package.

Figure 2. 7-Pin DDPACK^(A)

Please be aware that an important notice concerning availability, standard warranty, and use in critical applications of Texas Instruments semiconductor products and disclaimers thereto appears at the end of this data sheet.

All trademarks are the property of their respective owners.



These devices have limited built-in ESD protection. The leads should be shorted together or the device placed in conductive foam during storage or handling to prevent electrostatic damage to the MOS gates.

ABSOLUTE MAXIMUM RATINGS⁽¹⁾⁽²⁾

ESD Tolerance ⁽³⁾	Human Body Model	2.5 kV
	Machine Model	250V
Supply Voltage		36V (±18V)
Input to Output Voltage ⁽⁴⁾		±5V
Input Voltage		±V _{SUPPLY}
Output Short-Circuit to GND ⁽⁵⁾		Continuous
Storage Temperature Range		-65°C to +150°C
Junction Temperature (T _{JMAX})		+150°C
Lead Temperature (Soldering, 10 seconds)		260°C
Power Dissipation		⁽⁶⁾
C _L Pin to GND Voltage		±1.2V

- (1) Absolute Maximum Ratings indicate limits beyond which damage to the device may occur. Operating Ratings indicate conditions for which the device is intended to be functional, but specific performance is not ensured. For specifications and the test conditions, see the Electrical Characteristics Table.
- (2) If Military/Aerospace specified devices are required, please contact the Texas Instruments Sales Office/ Distributors for availability and specifications.
- (3) Human Body Model is 1.5 kΩ in series with 100 pF. Machine Model is 0Ω in series with 200 pF.
- (4) If the input-output voltage differential exceeds ±5V, internal clamping diodes will turn on. The current through these diodes should be limited to 5 mA max. Thus for an input voltage of ±15V and the output shorted to ground, a minimum of 2 kΩ should be placed in series with the input.
- (5) The maximum continuous current must be limited to 300mA. See [APPLICATION HINTS](#) for more details.
- (6) The maximum power dissipation is a function of T_{J(MAX)}, θ_{JA}, and T_A. The maximum allowable power dissipation at any ambient temperature is P_D = (T_{J(MAX)} - T_A) / θ_{JA}. See [THERMAL MANAGEMENT](#) of [APPLICATION HINTS](#).

OPERATING RATINGS

Operating Temperature Range		-40°C to +125°C
Operating Supply Range		5V to ±16V
Thermal Resistance (θ _{JA})		
SO PowerPAD Package ⁽¹⁾		180°C/W
Thermal Resistance (θ _{JC})	DDPAK Package	4°C/W
Thermal Resistance (θ _{JA})		80°C/W

- (1) Soldered to PC board with copper foot print equal to DAP size. Natural convection (no air flow). Board material is FR-4.

±15V ELECTRICAL CHARACTERISTICS

The following specifications apply for Supply Voltage = ±15V, $V_{CM} = 0$, $R_L \geq 100\text{ k}\Omega$ and $R_S = 50\Omega$, C_L open, unless otherwise noted. **Boldface** limits apply for $T_A = T_J = T_{MIN}$ to T_{MAX} ; all other limits $T_A = T_J = 25^\circ\text{C}$.

Symbol	Parameter	Conditions	Min	Typ	Max	Units
A_V	Voltage Gain	$R_L = 1\text{ k}\Omega$, $V_{IN} = \pm 10\text{V}$	0.99 0.98	0.995		V/V
		$R_L = 50\Omega$, $V_{IN} = \pm 10\text{V}$	0.86 0.84	0.92		V/V
V_{OS}	Input Offset Voltage	$R_L = 1\text{ k}\Omega$, $R_S = 0\text{V}$		±4	±35 ±52	mV
I_B	Input Bias Current	$V_{IN} = 0\text{V}$, $R_L = 1\text{ k}\Omega$, $R_S = 0\text{V}$		±2	±15 ±17	μA
R_{IN}	Input Resistance	$R_{L} = 50\Omega$		250		kΩ
C_{IN}	Input Capacitance			3.5		pF
R_O	Output Resistance	$I_O = \pm 10\text{ mA}$		5		Ω
I_S	Power Supply Current	$R_L = \infty$, $V_{IN} = 0$		11	14.5 16.5	mA
		750 μA into C_L Pin		14.9	18.5 20.5	
V_{O1}	Positive Output Swing	$I_O = 300\text{ mA}$, $R_S = 0\text{V}$, $V_{IN} = \pm V_S$	11.2 10.8	11.9		V
	Negative Output Swing	$I_O = 300\text{ mA}$, $R_S = 0\text{V}$, $V_{IN} = \pm V_S$		-11.3	-10.3 -9.8	
V_{O2}	Positive Output Swing	$R_L = 1\text{ k}\Omega$, $R_S = 0\text{V}$, $V_{IN} = \pm V_S$	13.1 12.9	13.4		V
	Negative Output Swing	$R_L = 1\text{ k}\Omega$, $R_S = 0\text{V}$, $V_{IN} = \pm V_S$		-13.4	-12.9 -12.6	
V_{O3}	Positive Output Swing	$R_L = 50\Omega$, $R_S = 0\text{V}$, $V_{IN} = \pm V_S$	11.6 11.2	12.2		V
	Negative Output Swing	$R_L = 50\Omega$, $R_S = 0\text{V}$, $V_{IN} = \pm V_S$		-11.9	-10.9 -10.6	
V_{EF}	Error Flag Output Voltage	$R_L = \infty$, $V_{IN} = 0$, EF pulled up with 5 kΩ to +5V	Normal		5.00	V
			During Thermal Shutdown		0.25	
T_{SH}	Thermal Shutdown Temperature	Measure Quantity is Die (Junction) Temperature		168		°C
		Hysteresis		10		
I_{SH}	Supply Current at Thermal Shutdown	EF pulled up with 5 kΩ to +5V		3		mA
PSSR	Power Supply Rejection Ratio	$R_L = 1\text{ k}\Omega$, $V_{IN} = 0\text{V}$, $V_S = \pm 5\text{V}$ to $\pm 15\text{V}$	Positive	58 54	66	dB
			Negative	58 54	64	
SR	Slew Rate	$V_{IN} = \pm 11\text{V}$, $R_L = 1\text{ k}\Omega$		2900		V/μs
		$V_{IN} = \pm 11\text{V}$, $R_L = 50\Omega$		1800		
BW	-3 dB Bandwidth	$V_{IN} = \pm 20\text{ mV}_{PP}$, $R_L = 50\Omega$		110		MHz
LSBW	Large Signal Bandwidth	$V_{IN} = 2\text{ V}_{PP}$, $R_L = 50\Omega$		48		MHz
HD2	2 nd Harmonic Distortion	$V_O = 2\text{ V}_{PP}$, $f = 100\text{ kHz}$	$R_L = 50\Omega$		-59	dBc
			$R_L = 100\Omega$		-70	
		$V_O = 2\text{ V}_{PP}$, $f = 1\text{ MHz}$	$R_L = 50\Omega$		-57	
			$R_L = 100\Omega$		-68	

±15V ELECTRICAL CHARACTERISTICS (continued)

The following specifications apply for Supply Voltage = ±15V, $V_{CM} = 0$, $R_L \geq 100\text{ k}\Omega$ and $R_S = 50\Omega$, C_L open, unless otherwise noted. **Boldface** limits apply for $T_A = T_J = T_{MIN}$ to T_{MAX} ; all other limits $T_A = T_J = 25^\circ\text{C}$.

Symbol	Parameter	Conditions	Min	Typ	Max	Units	
HD3	3rd Harmonic Distortion	$V_O = 2 V_{PP}$, $f = 100\text{ kHz}$	$R_L = 50\Omega$		-59	dBc	
			$R_L = 100\Omega$		-70		
		$V_O = 2 V_{PP}$, $f = 1\text{ MHz}$	$R_L = 50\Omega$		-62		
			$R_L = 100\Omega$		-73		
e_n	Input Voltage Noise	$f \geq 10\text{ kHz}$		2.8		$\text{nV}/\sqrt{\text{Hz}}$	
i_n	Input Current Noise	$f \geq 10\text{ kHz}$		2.4		$\text{pA}/\sqrt{\text{Hz}}$	
I_{SC1}	Output Short Circuit Current Source ⁽¹⁾	$V_O = 0V$, Program Current into $C_L = 25\text{ }\mu\text{A}$	Sourcing $V_{IN} = +3V$	4.5 4.5	10	15.5 15.5	mA
			Sinking $V_{IN} = -3V$	4.5 4.5	10	15.5 15.5	
		$V_O = 0V$ Program Current into $C_L = 750\text{ }\mu\text{A}$	Sourcing $V_{IN} = +3V$	280 273	295	308 325	mA
			Sinking $V_{IN} = -3V$	280 275	295	310 325	
I_{SC2}	Output Short Circuit Current Source	$R_S = 0V$, $V_{IN} = +3V^{(1)(2)}$	320 300	570	750 920	mA	
	Output Short Circuit Current Sink	$R_S = 0V$, $V_{IN} = -3V^{(1)(2)}$	300 305	515	750 910		
V/I Section							
CLV _{OS}	Current Limit Input Offset Voltage	$R_L = 1\text{ k}\Omega$, GND = 0V		±0.5	±4.0 ±8.0	mV	
CLI _B	Current Limit Input Bias Current	$R_L = 1\text{ k}\Omega$	-0.5 -0.8	-0.2		μA	
CL CMRR	Current Limit Common Mode Rejection Ratio	$R_L = 1\text{ k}\Omega$, GND = -13 to +14V	60 56	69		dB	

(1) $V_{IN} = +$ or $-4V$ at $T_J = -40^\circ\text{C}$.

(2) For the condition where the C_L pin is left open the output current should not be continuous, but instead, should be limited to low duty cycle pulse mode such that the RMS output current is less than or equal to 300 mA.

±5V ELECTRICAL CHARACTERISTICS

The following specifications apply for Supply Voltage = ±5V, $V_{CM} = 0$, $R_L \geq 100\text{ k}\Omega$ and $R_S = 50\Omega$, C_L Open, unless otherwise noted. **Boldface** limits apply for $T_A = T_J = T_{MIN}$ to T_{MAX} ; all other limits $T_A = T_J = 25^\circ\text{C}$.

Symbol	Parameter	Conditions	Min	Typ	Max	Units	
A_V	Voltage Gain	$R_L = 1\text{ k}\Omega$, $V_{IN} = \pm 3\text{V}$	0.99 0.98	0.994		V/V	
		$R_L = 50\Omega$, $V_{IN} = \pm 3\text{V}$	0.86 0.84	0.92			
V_{OS}	Offset Voltage	$R_L = 1\text{ k}\Omega$, $R_S = 0\text{V}$		±2.5	±35 ±50	mV	
I_B	Input Bias Current	$V_{IN} = 0\text{V}$, $R_L = 1\text{ k}\Omega$, $R_S = 0\text{V}$		±2	±15 ±17	µA	
R_{IN}	Input Resistance	$R_L = 50\Omega$		250		kΩ	
C_{IN}	Input Capacitance			3.5		pF	
R_O	Output Resistance	$I_{OUT} = \pm 10\text{ mA}$		5		Ω	
I_S	Power Supply Current	$R_L = \infty$, $V_{IN} = 0\text{V}$		10	13.5 14.7	mA	
		750 µA into CL Pin		14	17.5 19.5		
V_{O1}	Positive Output Swing	$I_O = 300\text{ mA}$, $R_S = 0\text{V}$, $V_{IN} = \pm V_S$	1.3 0.9	1.9		V	
	Negative Output Swing	$I_O = 300\text{ mA}$, $R_S = 0\text{V}$, $V_{IN} = \pm V_S$		-1.3	-0.5 -0.1		
V_{O2}	Positive Output Swing	$R_L = 1\text{ k}\Omega$, $R_S = 0\text{V}$, $V_{IN} = \pm V_S$	3.2 2.9	3.5		V	
	Negative Output Swing	$R_L = 1\text{ k}\Omega$, $R_S = 0\text{V}$, $V_{IN} = \pm V_S$		-3.5	-3.1 -2.9	V	
V_{O3}	Positive Output Swing	$R_L = 50\Omega$, $R_S = 0\text{V}$, $V_{IN} = \pm V_S$	2.8 2.5	3.1		V	
	Negative Output Swing	$R_L = 50\Omega$, $R_S = 0\text{V}$, $V_{IN} = \pm V_S$		-3.0	-2.6 -2.4	V	
PSSR	Power Supply Rejection Ratio	$R_L = 1\text{ k}\Omega$, $V_{IN} = 0$, $V_S = \pm 5\text{V}$ to $\pm 15\text{V}$	Positive	58 54	66		dB
			Negative	58 54	64		
I_{SC1}	Output Short Circuit Current	$V_O = 0\text{V}$, Program Current into $C_L = 25\text{ }\mu\text{A}$	Sourcing $V_{IN} = +3\text{V}$	4.5 4.5	9	14.0 15.5	mA
			Sinking $V_{IN} = -3\text{V}$	4.5 4.5	9	14.0 15.5	
		$V_O = 0\text{V}$, Program Current into $C_L = 750\text{ }\mu\text{A}$	Sourcing $V_{IN} = +3\text{V}$	275 270	290	305 320	
			Sinking $V_{IN} = -3\text{V}$	275 270	290	310 320	
I_{SC2}	Output Short Circuit Current Source	$R_S = 0\text{V}$, $V_{IN} = +3\text{V}^{(1)(2)}$	300	470		mA	
	Output Short Circuit Current Sink	$R_S = 0\text{V}$, $V_{IN} = -3\text{V}^{(1)(2)}$	300	400			
SR	Slew Rate	$V_{IN} = \pm 2 V_{PP}$, $R_L = 1\text{ k}\Omega$		450		V/µs	
		$V_{IN} = \pm 2 V_{PP}$, $R_L = 50\Omega$		210			
BW	-3 dB Bandwidth	$V_{IN} = \pm 20\text{ mV}_{PP}$, $R_L = 50\Omega$		90		MHz	
LSBW	Large Signal Bandwidth	$V_{IN} = 2 V_{PP}$, $R_L = 50\Omega$		39		MHz	
T_{SD}	Thermal Shutdown	Temperature		170		°C	
		Hysteresis		10			

V/I Section

- (1) For the condition where the C_L pin is left open the output current should not be continuous, but instead, should be limited to low duty cycle pulse mode such that the RMS output current is less than or equal to 300 mA.
- (2) $V_{IN} = +$ or -4V at $T_J = -40^\circ\text{C}$.

±5V ELECTRICAL CHARACTERISTICS (continued)

The following specifications apply for Supply Voltage = ±5V, $V_{CM} = 0$, $R_L \geq 100\text{ k}\Omega$ and $R_S = 50\Omega$, C_L Open, unless otherwise noted. **Boldface** limits apply for $T_A = T_J = T_{MIN}$ to T_{MAX} ; all other limits $T_A = T_J = 25^\circ\text{C}$.

Symbol	Parameter	Conditions	Min	Typ	Max	Units
CLV _{OS}	Current Limit Input Offset Voltage	$R_L = 1\text{ k}\Omega$, GND = 0V		2.7	+5 ±5.0	mV
CLI _B	Current Limit Input Bias Current	$R_L = 1\text{ k}\Omega$, $C_L = 0\text{V}$	-0.5 -0.6	-0.2		μA
CL CMRR	Current Limit Common Mode Rejection Ratio	$R_L = 1\text{ k}\Omega$, GND = -3V to +4V	60 56	65		dB

TYPICAL PERFORMANCE CHARACTERISTICS

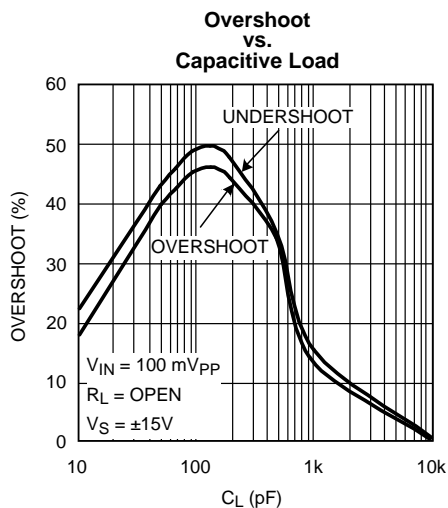

Figure 3.

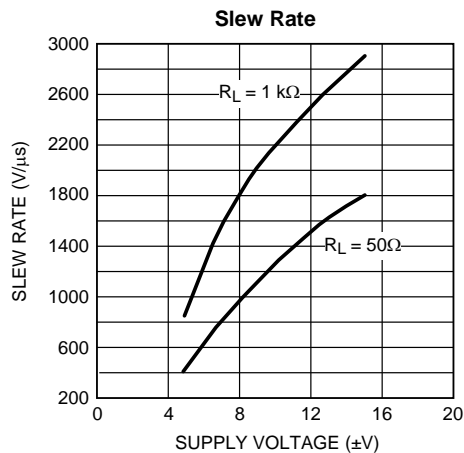

Figure 4.

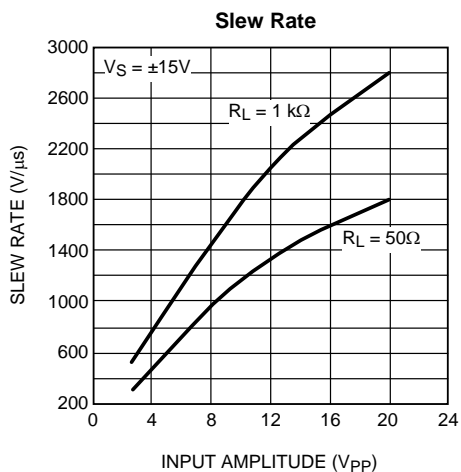

Figure 5.

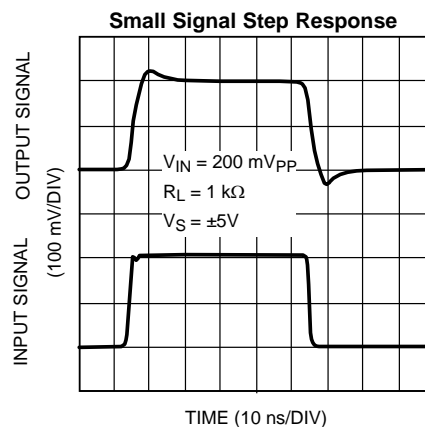

Figure 6.

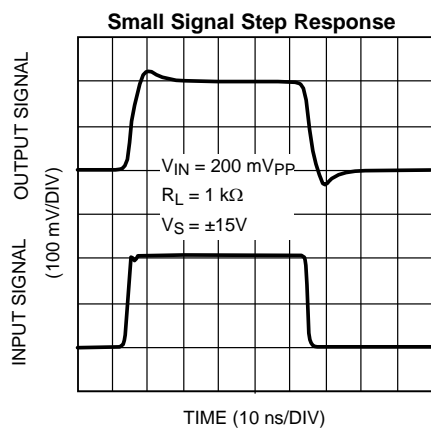

Figure 7.

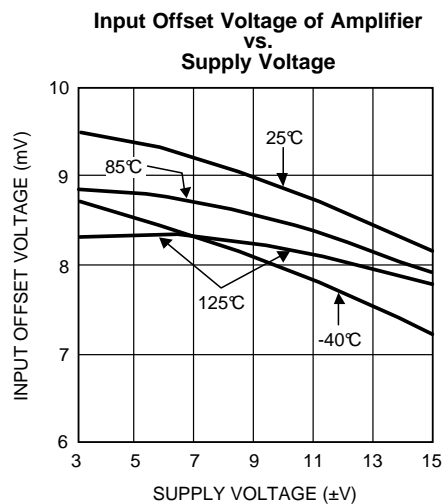
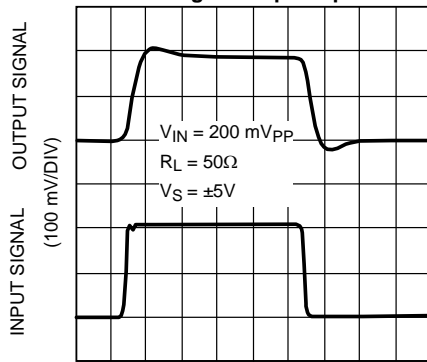

Figure 8.

TYPICAL PERFORMANCE CHARACTERISTICS (continued)

Small Signal Step Response



TIME (10 ns/DIV)

Figure 9.

Small Signal Step Response

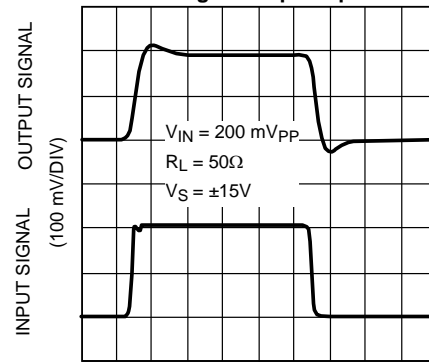

TIME (10 ns/DIV)

Figure 10.

Large Signal Step Response—Leading Edge

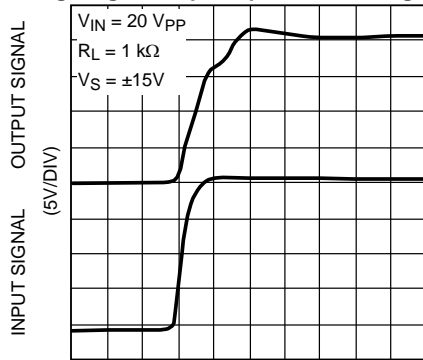

TIME (5 ns/DIV)

Figure 11.

Large Signal Step Response—Leading Edge

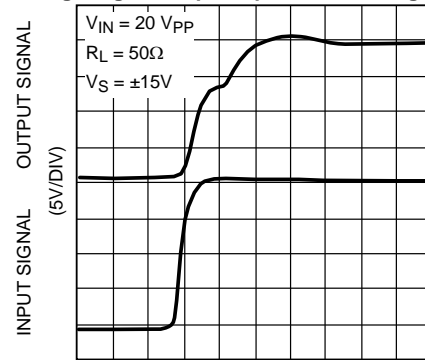

TIME (5 ns/DIV)

Figure 12.

Large Signal Step Response — Trailing Edge

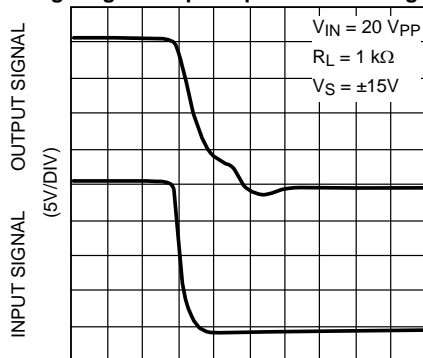

TIME (5 ns/DIV)

Figure 13.

Large Signal Step Response — Trailing Edge

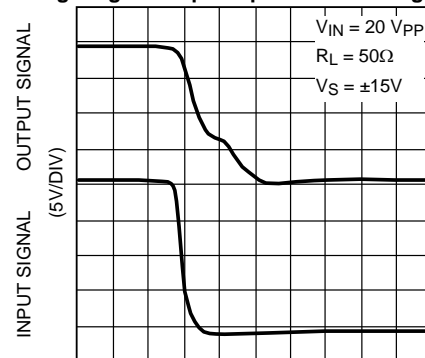

TIME (5 ns/DIV)

Figure 14.

TYPICAL PERFORMANCE CHARACTERISTICS (continued)

Large Signal Step Response

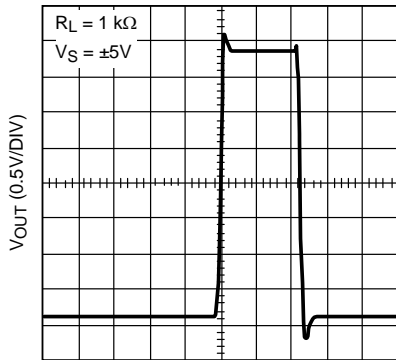

TIME (20 ns/DIV)
Figure 15.

Large Signal Step Response

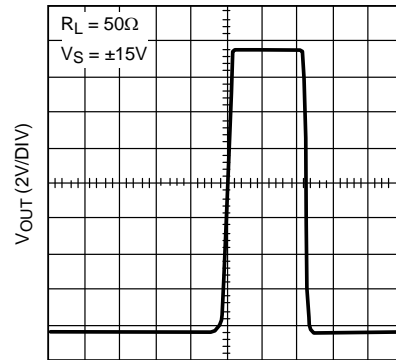

TIME (20 ns/DIV)
Figure 16.

Large Signal Step Response

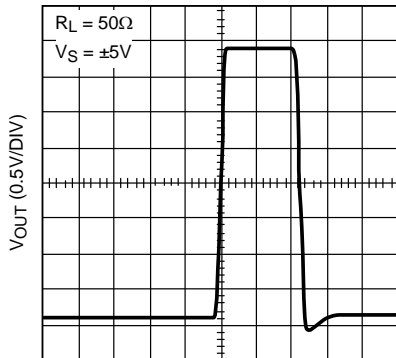

TIME (20 ns/DIV)
Figure 17.

Large Signal Step Response

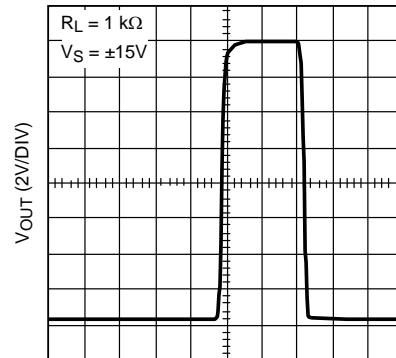

TIME (20 ns/DIV)
Figure 18.

Harmonic Distortion with 50Ω Load

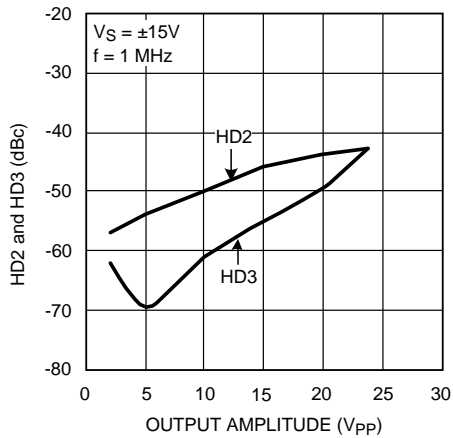

Figure 19.

Harmonic Distortion with 100Ω Load

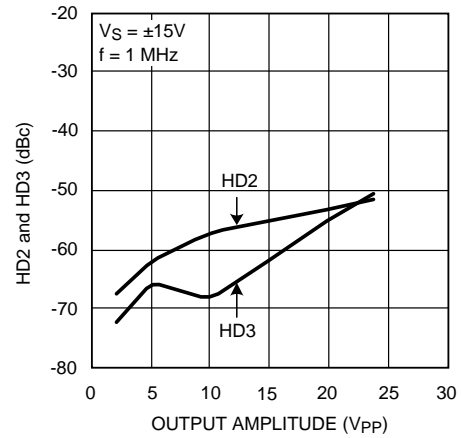

Figure 20.

TYPICAL PERFORMANCE CHARACTERISTICS (continued)

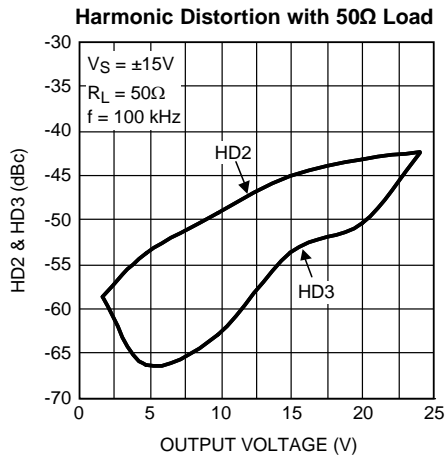

Figure 21.

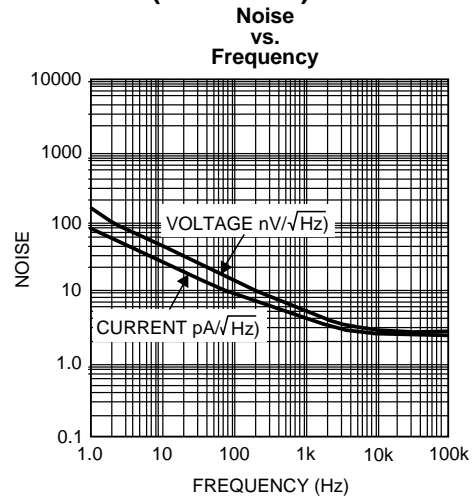

Figure 22.

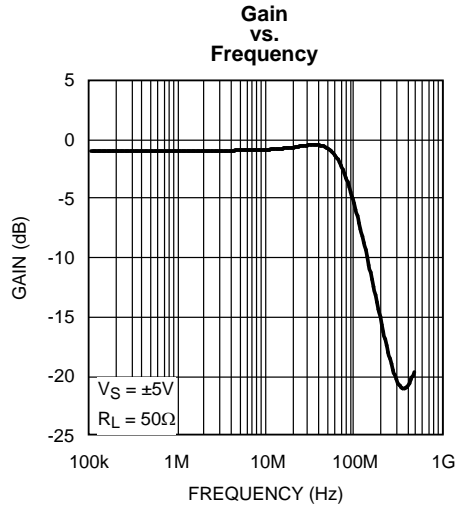

Figure 23.

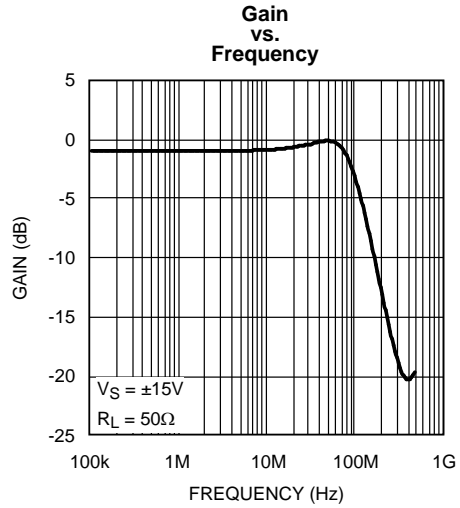

Figure 24.

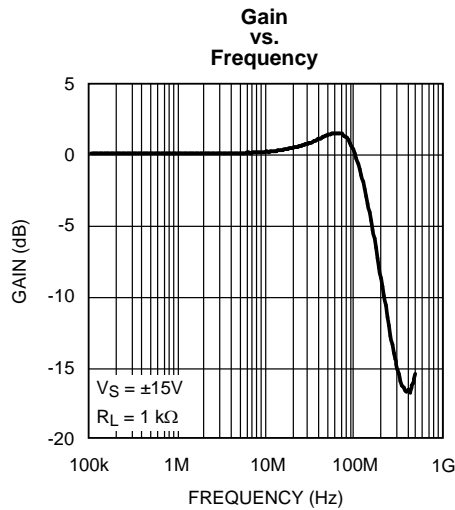

Figure 25.

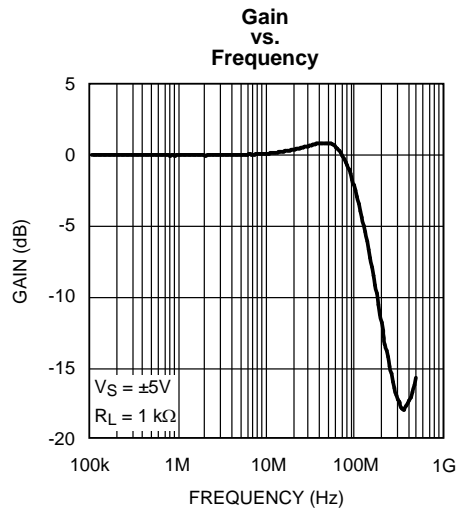

Figure 26.

TYPICAL PERFORMANCE CHARACTERISTICS (continued)

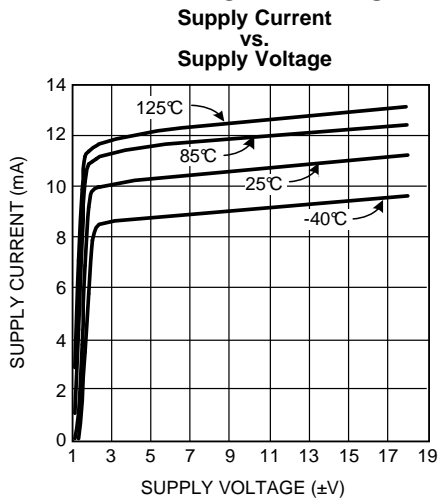

Figure 27.

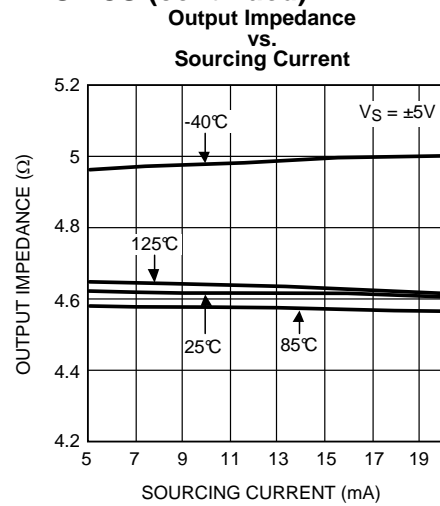

Figure 28.

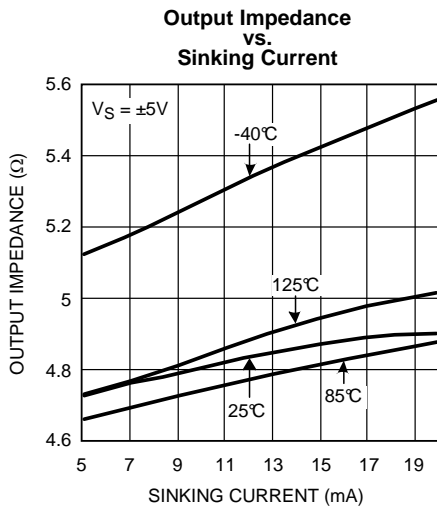

Figure 29.

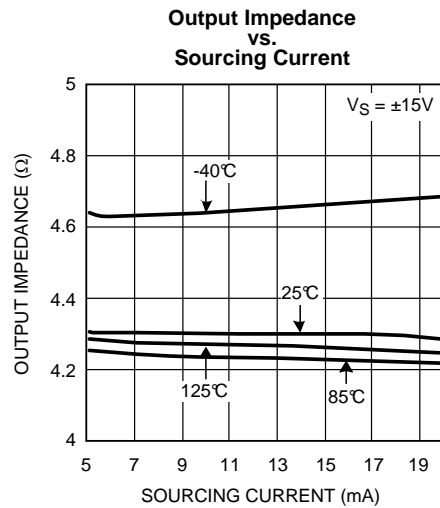

Figure 30.

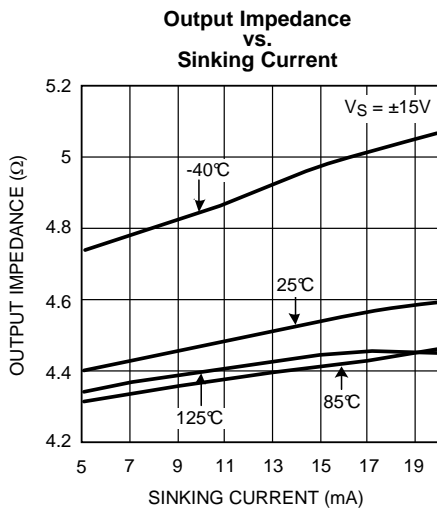

Figure 31.

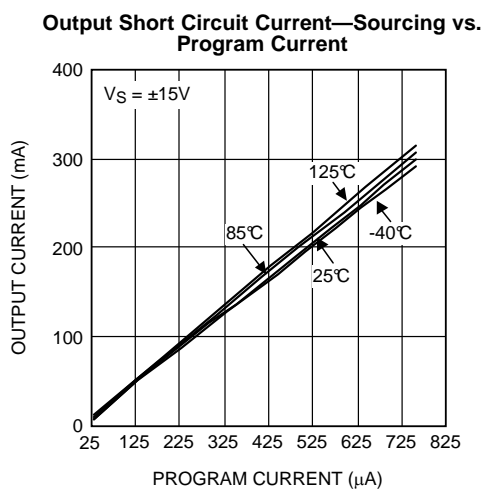

Figure 32.

TYPICAL PERFORMANCE CHARACTERISTICS (continued)

Output Short Circuit Current—Sinking vs. Program Current

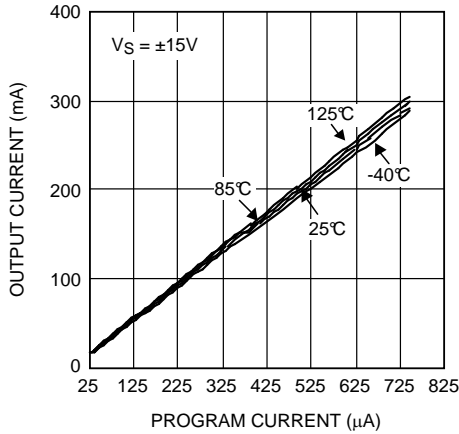

Figure 33.

Output Short Circuit Current—Sourcing vs. Program Current

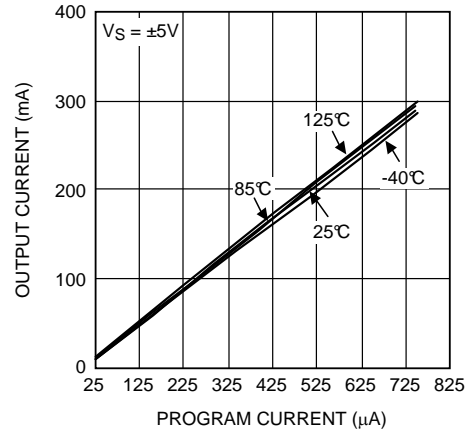

Figure 34.

Output Short Circuit Current—Sinking vs. Program Current

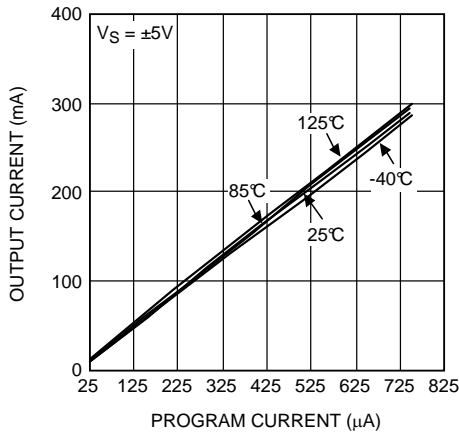

Figure 35.

Positive Output Swing vs. Sourcing Current

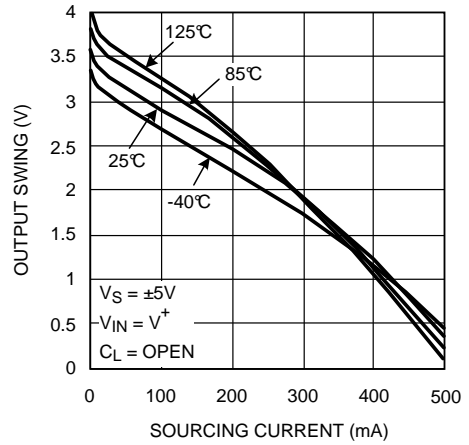

Figure 36.

Negative Output Swing vs. Sinking Current

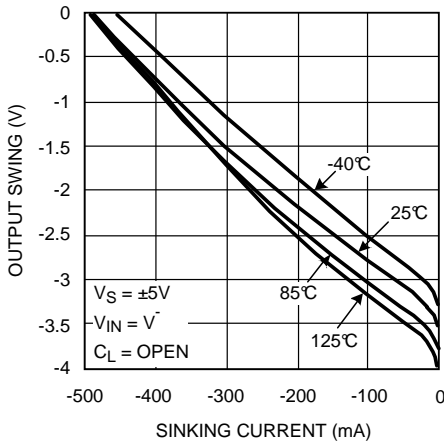

Figure 37.

Positive Output Swing vs. Sourcing Current

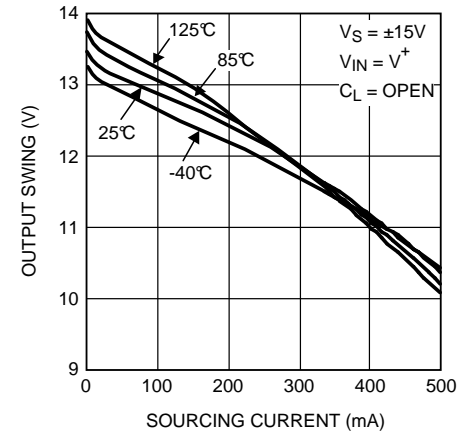

Figure 38.

TYPICAL PERFORMANCE CHARACTERISTICS (continued)

Negative Output Swing vs. Sinking Current

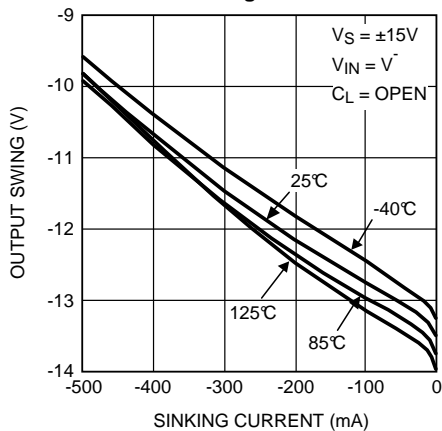

Figure 39.

Output Short Circuit Current—Sourcing vs. Supply Voltage

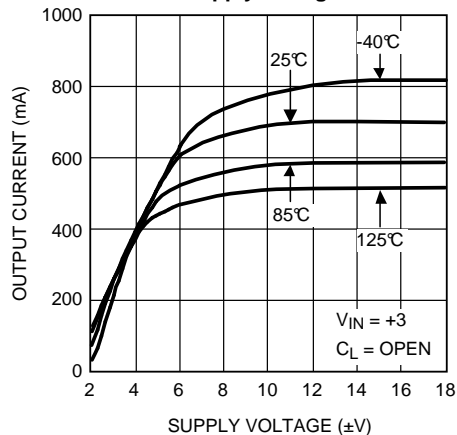

Figure 40.

Output Short Circuit Current—Sinking vs. Supply Voltage

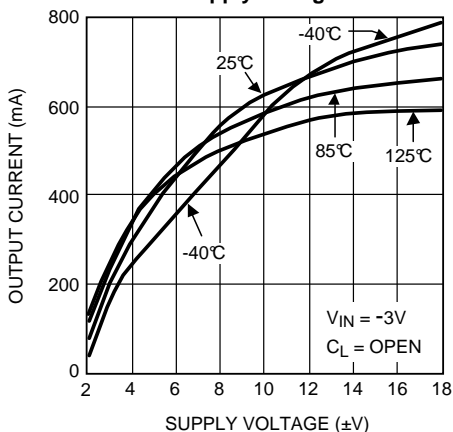

Figure 41.

Positive Output Swing vs. Supply Voltage

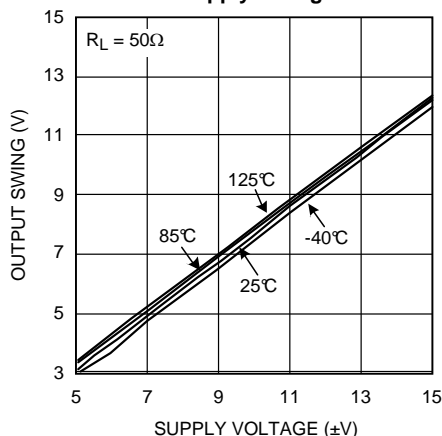

Figure 42.

Positive Output Swing vs. Supply Voltage

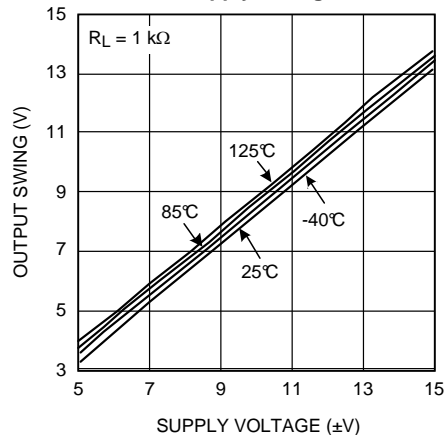

Figure 43.

Negative Output Swing vs. Supply Voltage

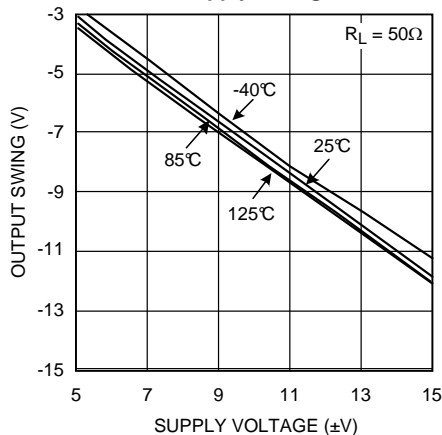

Figure 44.

TYPICAL PERFORMANCE CHARACTERISTICS (continued)
Negative Output Swing vs. Supply Voltage

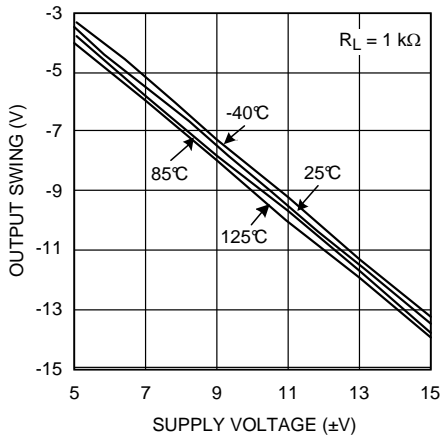

Figure 45.

Input Offset Voltage of Amplifier vs. Common Mode Voltage

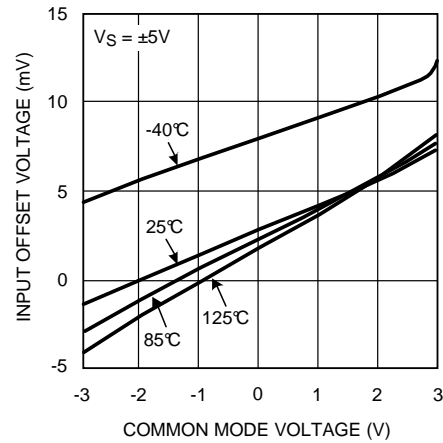

Figure 46.

Input Offset Voltage of Amplifier vs. Common Mode Voltage

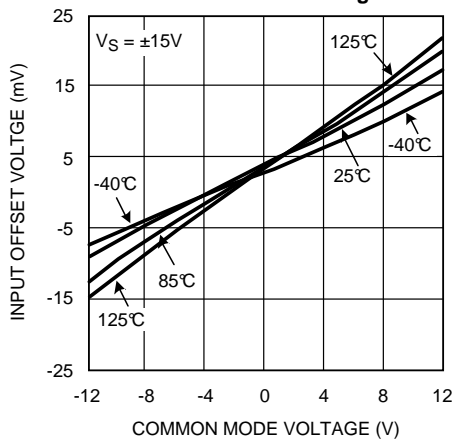

Figure 47.

Input Bias Current of Amplifier vs. Supply Voltage

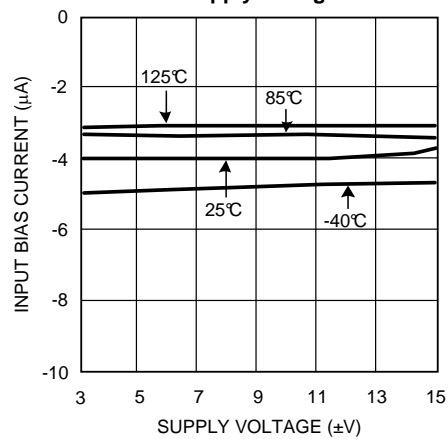

Figure 48.

Input Offset Voltage of V/I Section vs. Common Mode Voltage

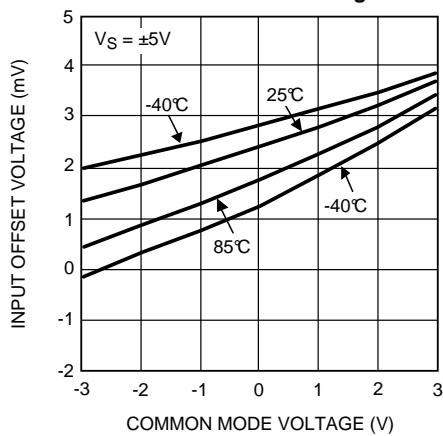

Figure 49.

Input Offset Voltage of V/I Section vs. Common Mode Voltage

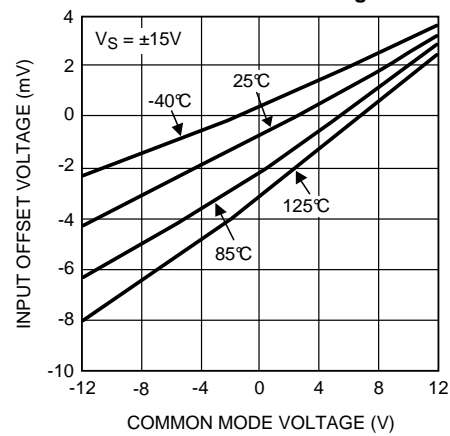

Figure 50.

APPLICATION HINTS

BUFFERS

Buffers are often called voltage followers because they have largely unity voltage gain, thus the name has generally come to mean a device that supplies current gain but no voltage gain. Buffers serve in applications requiring isolation of source and load, i.e., high input impedance, low output impedance (high output current drive). In addition, they offer gain flatness and wide bandwidth.

Most operational amplifiers, that meet the other given requirements in a particular application, can be configured as buffers, though they are generally more complex and are, by and large, not optimized for unity gain operation. The commercial buffer is a cost effective substitute for an op amp. Buffers serve several useful functions, either in tandem with op amps or in standalone applications. As mentioned, their primary function is to isolate a high impedance source from a low impedance load, since a high Z source can't supply the needed current to the load. For example, in the case where the signal source to an analog to digital converter is a sensor, it is recommended that the sensor be isolated from the A/D converter. The use of a buffer ensures a low output impedance and delivery of a stable output to the converter. In A/D converter applications buffers need to drive varying and complex reactive loads.

Buffers come in two flavors: Open Loop and Closed Loop. While sacrificing the precision of some DC characteristics, and generally displaying poorer gain linearity, open loop buffers offer lower cost and increased bandwidth, along with less phase shift and propagation delay than do closed loop buffers. The LMH6321 is of the open loop variety.

Figure 51 shows a simplified diagram of the LMH6321 topology, revealing the open loop complementary follower design approach. Figure 52 shows the LMH6321 in a typical application, in this case, a 50Ω coaxial cable driver.

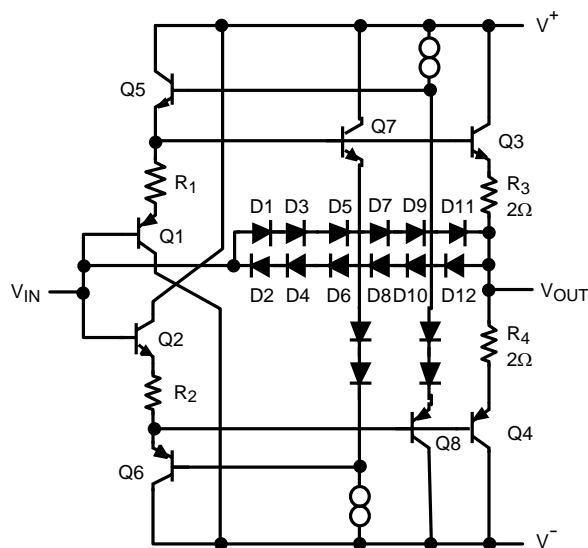

Figure 51. Simplified Schematic

SUPPLY BYPASSING

The method of supply bypassing is not critical for frequency stability of the buffer, and, for light loads, capacitor values in the neighborhood of 1 nF to 10 nF are adequate. However, under fast slewing and large loads, large transient currents are demanded of the power supplies, and when combined with any significant wiring inductance, these currents can produce voltage transients. For example, the LMH6321 can slew typically at 1000 V/μs. Therefore, under a 50Ω load condition the load can demand current at a rate, di/dt, of 20 A/μs. This current flowing in an inductance of 50 nH (approximately 1.5" of 22 gage wire) will produce a 1V transient. Thus, it is recommended that solid tantalum capacitors of 5 μF to 10 μF, in parallel with a ceramic 0.1 μF capacitor be added as close as possible to the device supply pins.

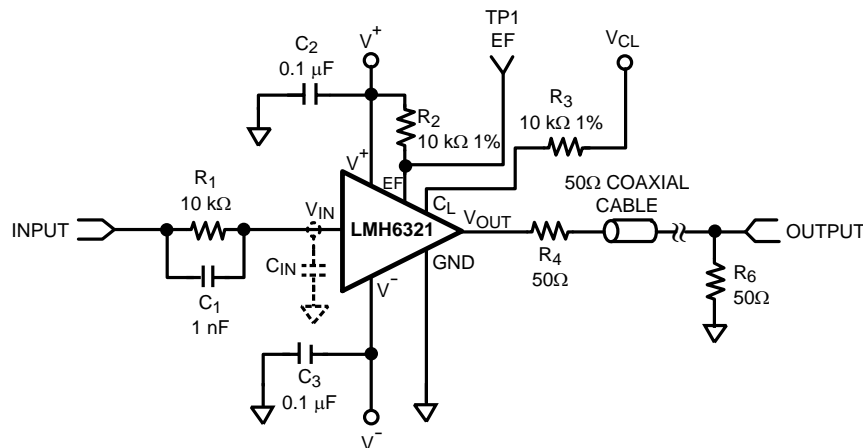

Figure 52. 50Ω Coaxial Cable Driver with Dual Supplies

For values of capacitors in the 10 μF to 100 μF range, ceramics are usually larger and more costly than tantalums but give superior AC performance for bypassing high frequency noise because of their very low ESR (typically less than 10 $\text{m}\Omega$) and low ESL.

LOAD IMPEDANCE

The LMH6321 is stable under any capacitive load when driven by a 50 Ω source. As shown by [Figure 3](#) in [TYPICAL PERFORMANCE CHARACTERISTICS](#), worst case overshoot is for a purely capacitive load of about 1 nF. Shunting the load capacitance with a resistor will reduce the overshoot.

SOURCE INDUCTANCE

Like any high frequency buffer, the LMH6321 can oscillate with high values of source inductance. The worst case condition occurs with no input resistor, and a purely capacitive load of 50 pF, where up to 100 nH of source inductance can be tolerated. With a 50 Ω load, this goes up to 200 nH. However, a 100 Ω resistor placed in series with the buffer input will ensure stability with a source inductances up to 400 nH with any load.

OVERVOLTAGE PROTECTION

(Refer to the simplified schematic in [Figure 51](#)).

If the input-to-output differential voltage were allowed to exceed the Absolute Maximum Rating of 5V, an internal diode clamp would turn on and divert the current around the compound emitter followers of Q1/Q3 (D1 – D11 for positive input), or around Q2/Q4 (D2 – D12 for negative inputs). Without this clamp, the input transistors Q1 – Q4 would zener, thereby damaging the buffer.

To limit the current through this clamp, a series resistor should be added to the buffer input (see R_1 in [Figure 52](#)). Although the allowed current in the clamp can be as high as 5 mA, which would suggest a 2 k Ω resistor from a 15V source, it is recommended that the current be limited to about 1 mA, hence the 10 k Ω shown.

The reason for this larger resistor is explained in the following: One way that the input/output voltage differential can exceed the Abs Max value is under a short circuit condition to ground while driving the input with up to $\pm 15\text{V}$. However, in the LMH6321 the maximum output current is set by the programmable Current Limit pin (C_L). The value set by this pin is specified to be accurate to 5 mA $\pm 5\%$. If the input/output differential exceeds 5V while the output is trying to supply the maximum set current to a shorted condition or to a very low resistance load, a portion of that current will flow through the clamp diodes, thus creating an error in the total load current. If the input resistor is too low, the error current can exceed the 5 mA $\pm 5\%$ budget.

BANDWIDTH AND STABILITY

As can be seen in the schematic of [Figure 52](#), a small capacitor is inserted in parallel with the series input resistors. The reason for this is to compensate for the natural band-limiting effect of the 1st order filter formed by this resistor and the input capacitance of the buffer. With a typical C_{IN} of 3.5 pF ([Figure 52](#)), a pole is created at

$$f_{p2} = 1/(2\pi R_1 C_{IN}) = 4.5 \text{ MHz} \quad (1)$$

This will band-limit the buffer and produce further phase lag. If used in an op amp-loop application with an amplifier that has the same order of magnitude of unity gain crossing as f_{p2} , this additional phase lag will produce oscillation.

The solution is to add a small feed-forward capacitor (phase lead) around the input resistor, as shown in [Figure 52](#). The value of this capacitor is not critical but should be such that the time constant formed by it and the input resistor that it is in parallel with (R_{IN}) be at least five times the time constant of $R_{IN}C_{IN}$. Therefore,

$$C_1 = (5R_{IN}/R_1)(C_{IN}) \quad (2)$$

from [Electrical Characteristics](#), R_{IN} is 250 k Ω .

In the case of the example in [Figure 52](#), $R_{IN}C_{IN}$ produces a time-constant of 870 ns, so C_1 should be chosen to be a minimum of 4.4 μ s, or 438 pF. The value of C_1 (1000 pF) shown in [Figure 52](#) gives 10 μ s.

OUTPUT CURRENT AND SHORT CIRCUIT PROTECTION

The LMH6321 is designed to deliver a maximum continuous output current of 300 mA. However, the maximum available current, set by internal circuitry, is about 700 mA at room temperature. The output current is programmable up to 300 mA by a single external resistor and voltage source.

The LMH6321 is not designed to safely output 700 mA continuously and should not be used this way. However, the available maximum continuous current will likely be limited by the particular application and by the package type chosen, which together set the thermal conditions for the buffer (see [THERMAL MANAGEMENT](#)) and could require less than 300 mA.

The programming of both the sourcing and sinking currents into the load is accomplished with a single resistor. [Figure 53](#) shows a simplified diagram of the V to I converter and I_{SC} protection circuitry that, together, perform this task.

Referring to [Figure 53](#), the two simplified functional blocks, labeled V/I Converter and Short Circuit Protection, comprise the circuitry of the Current Limit Control.

The V/I converter consists of error amplifier A1 driving two PNP transistors in a Darlington configuration. The two input connections to this amplifier are V_{CL} (inverting input) and GND (non-inverting input). If GND is connected to zero volts, then the high open loop gain of A1, as well as the feedback through the Darlington, will force C_L , and thus one end R_{EXT} to be at zero volts also. Therefore, a voltage applied to the other end of R_{EXT} will force a current

$$I_{EXT} = V_{PROG}/R_{EXT} \quad (3)$$

into this pin. Via this pin, I_{OUT} is programmable from 10 mA to 300 mA by setting I_{EXT} from 25 μ A to 750 μ A by means of a fixed R_{EXT} of 10 k Ω and making V_{CL} variable from 0.25V to 7.5V. Thus, an input voltage V_{CL} is converted to a current I_{EXT} . This current is the output from the V/I converter. It is gained up by a factor of two and sent to the Short Circuit Protection block as I_{PROG} . I_{PROG} sets a voltage drop across R_{SC} which is applied to the non-inverting input of error amp A2. The other input is across R_{SENSE} . The current through R_{SENSE} , and hence the voltage drop across it, is proportional to the load current, via the current sense transistor Q_{SENSE} . The output of A2 controls the drive (I_{DRIVE}) to the base of the NPN output transistor, Q3 which is, proportional to the amount and polarity of the voltage differential (V_{DIFF}) between AMP2 inputs, that is, how much the voltage across R_{SENSE} is greater than or less than the voltage across R_{SC} . This loop gains I_{EXT} up by another 200, thus

$$I_{SC} = 2 \times 200 (I_{EXT}) = 400 I_{EXT} \quad (4)$$

Therefore, combining [Equation 3](#) and [Equation 4](#), and solving for R_{EXT} , we get

$$R_{EXT} = 400 V_{PROG}/I_{SC} \quad (5)$$

If the V_{CL} pin is left open, the output short circuit current will default to about 700 mA. At elevated temperatures this current will decrease.

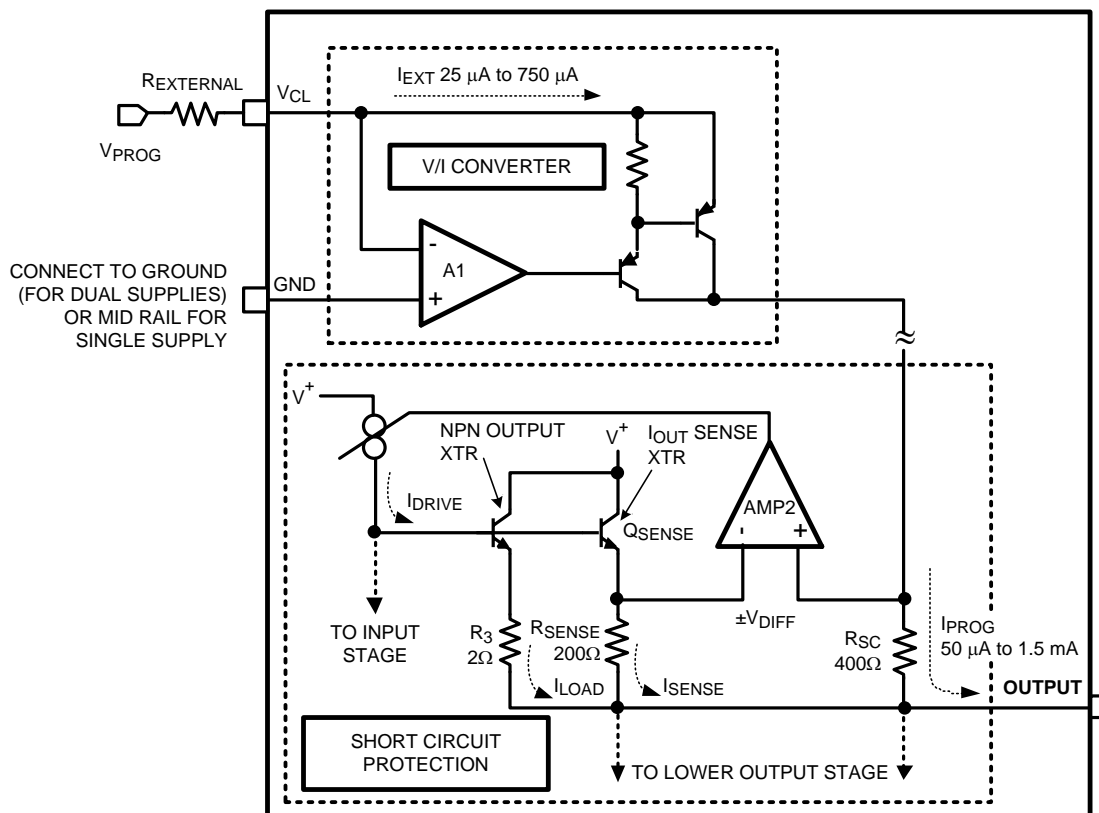

Only the NPN output I_{SC} protection is shown. Depending on the polarity of V_{DIFF} , AMP2 will turn I_{DRIVE} either on or off.

Figure 53. Simplified Diagram of Current Limit Control

THERMAL MANAGEMENT

Heatsinking

For some applications, a heat sink may be required with the LMH6321. This depends on the maximum power dissipation and maximum ambient temperature of the application. To accomplish heat sinking, the tabs on DDPAK and SO PowerPAD package may be soldered to the copper plane of a PCB for heatsinking (note that these tabs are electrically connected to the most negative point in the circuit, i. e., V^-).

Heat escapes from the device in all directions, mainly through the mechanisms of convection to the air above it and conduction to the circuit board below it and then from the board to the air. Natural convection depends on the amount of surface area that is in contact with the air. If a conductive plate serving as a heatsink is thick enough to ensure perfect thermal conduction (heat spreading) into the far recesses of the plate, the temperature rise would be simply inversely proportional to the total exposed area. PCB copper planes are, in that sense, an aid to convection, the difference being that they are not thick enough to ensure perfect conduction. Therefore, eventually we will reach a point of diminishing returns (as seen in Figure 55). Very large increases in the copper area will produce smaller and smaller improvement in thermal resistance. This occurs, roughly, for a 1 inch square of 1 oz copper board. Some improvement continues until about 3 square inches, especially for 2 oz boards and better, but beyond that, external heatsinks are required. Ultimately, a reasonable practical value attainable for the junction to ambient thermal resistance is about 30 °C/W under zero air flow.

A copper plane of appropriate size may be placed directly beneath the tab or on the other side of the board. If the conductive plane is placed on the back side of the PCB, it is recommended that thermal vias be used per JEDEC Standard JESD51-5.

Determining Copper Area

One can determine the required copper area by following a few basic guidelines:

1. Determine the value of the circuit's power dissipation, P_D
2. Specify a maximum operating ambient temperature, $T_{A(MAX)}$. Note that when specifying this parameter, it must be kept in mind that, because of internal temperature rise due to power dissipation, the die temperature, T_J , will be higher than T_A by an amount that is dependent on the thermal resistance from junction to ambient, θ_{JA} . Therefore, T_A must be specified such that T_J does not exceed the absolute maximum die temperature of 150°C.
3. Specify a maximum allowable junction temperature, $T_{J(MAX)}$, which is the temperature of the chip at maximum operating current. Although no strict rules exist, typically one should design for a maximum continuous junction temperature of 100°C to 130°C, but no higher than 150°C which is the absolute maximum rating for the part.
4. Calculate the value of junction to ambient thermal resistance, θ_{JA}
5. Choose a copper area that will ensure the specified $T_{J(MAX)}$ for the calculated θ_{JA} . θ_{JA} as a function of copper area in square inches is shown in [Figure 54](#).

The maximum value of thermal resistance, junction to ambient θ_{JA} , is defined as:

$$\theta_{JA} = (T_{J(MAX)} - T_{A(MAX)}) / P_{D(MAX)}$$

where

- $T_{J(MAX)}$ = the maximum recommended junction temperature
 - $T_{A(MAX)}$ = the maximum ambient temperature in the user's environment
 - $P_{D(MAX)}$ = the maximum recommended power dissipation
- (6)

NOTE

The allowable thermal resistance is determined by the maximum allowable heat rise, $T_{RISE} = T_{J(MAX)} - T_{A(MAX)} = (\theta_{JA}) (P_{D(MAX)})$. Thus, if ambient temperature extremes force T_{RISE} to exceed the design maximum, the part must be de-rated by either decreasing P_D to a safe level, reducing θ_{JA} , further, or, if available, using a larger copper area.

Procedure

1. First determine the maximum power dissipated by the buffer, $P_{D(MAX)}$. For the simple case of the buffer driving a resistive load, and assuming equal supplies, $P_{D(MAX)}$ is given by:

$$P_{D(MAX)} = I_S (2V^+) + V^{+2}/4R_L$$

where

- I_S = quiescent supply current
- (7)

2. Determine the maximum allowable die temperature rise,

$$T_{R(MAX)} = T_{J(MAX)} - T_{A(MAX)} = P_{D(MAX)} \theta_{JA}$$
(8)

3. Using the calculated value of $T_{R(MAX)}$ and $P_{D(MAX)}$ the required value for junction to ambient thermal resistance can be found:

$$\theta_{JA} = T_{R(MAX)} / P_{D(MAX)}$$
(9)

4. Finally, using this value for θ_{JA} choose the minimum value of copper area from [Figure 54](#).

Example

Assume the following conditions:

$$V^+ = V^- = 15V, R_L = 50\Omega, I_S = 15 \text{ mA } T_{J(MAX)} = 125^\circ\text{C}, T_{A(MAX)} = 85^\circ\text{C}.$$

1. From [Equation 7](#)

$$- P_{D(MAX)} = I_S (2V^+) + V^{+2}/4R_L = (15 \text{ mA})(30V) + 15V^2/200\Omega = 1.58W$$

2. From [Equation 8](#)

$$- T_{R(MAX)} = 125^\circ\text{C} - 85^\circ\text{C} = 40^\circ\text{C}$$

3. From [Equation 9](#)

$$- \theta_{JA} = 40^\circ\text{C}/1.58W = 25.3^\circ\text{C}/W$$

Examining [Figure 54](#), we see that we cannot attain this low of a thermal resistance for one layer of 1 oz copper. It will be necessary to derate the part by decreasing either the ambient temperature or the power dissipation. Other solutions are to use two layers of 1 oz foil, or use 2 oz copper (see [Table 1](#)), or to provide forced air flow. One should allow about an extra 15% heat sinking capability for safety margin.

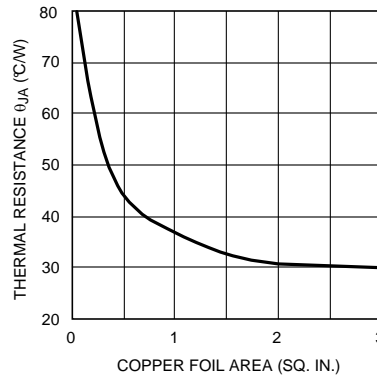

Figure 54. Thermal Resistance (typ) for 7-L DDPAK Package Mounted on 1 oz. (0.036 mm) PC Board Foil

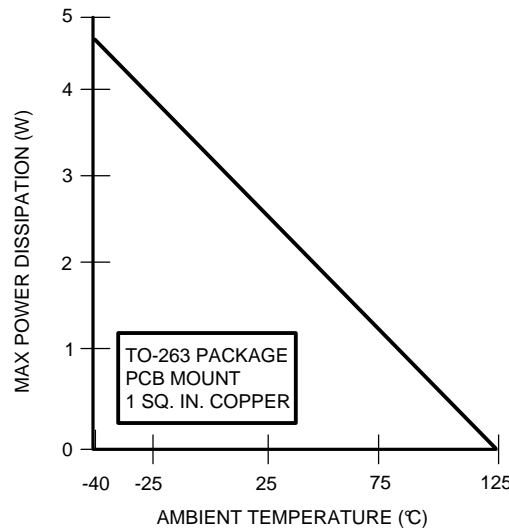

Figure 55. Derating Curve for DDPAK package. No Air Flow

Table 1. θ_{JA} vs. Copper Area and P_D for DDPAK. 1.0 oz cu Board. No Air Flow. Ambient Temperature = 24°C

Copper Area	θ_{JA} @ 1.0W (°C/W)	θ_{JA} @ 2.0W (°C/W)
1 Layer = 1"x2" cu Bottom	62.4	54.7
2 Layer = 1"x2" cu Top & Bottom	36.4	32.1
2 Layer = 2"x2" cu Top & Bottom	23.5	22.0
2 Layer = 2"x4" cu Top & Bottom	19.8	17.2

As seen in the previous example, buffer dissipation in DC circuit applications is easily computed. However, in AC circuits, signal wave shapes and the nature of the load (reactive, non-reactive) determine dissipation. Peak dissipation can be several times the average with reactive loads. It is particularly important to determine dissipation when driving large load capacitance.

A selection of thermal data for the SO PowerPAD package is shown in [Table 2](#). The table summarizes θ_{JA} for both 0.5 watts and 0.75 watts. Note that the thermal resistance, for both the DDPACK and the SO PowerPAD package is lower for the higher power dissipation levels. This phenomenon is a result of the principle of Newtons Law of Cooling. Restated in term of heatsink cooling, this principle says that the rate of cooling and hence the thermal conduction, is proportional to the temperature difference between the junction and the outside environment (ambient). This difference increases with increasing power levels, thereby producing higher die temperatures with more rapid cooling.

Table 2. θ_{JA} vs. Copper Area and P_D for SO PowerPAD. 1.0 oz cu Board. No Airflow. Ambient Temperature = 22°C

Copper Area/Vias	θ_{JA} @ 0.5W (°C/W)	θ_{JA} @ 0.75W (°C/W)
1 Layer = 0.05 sq. in. (Bottom) + 3 Via Pads	141.4	138.2
1 Layer = 0.1 sq. in. (Bottom) + 3 Via Pads	134.4	131.2
1 Layer = 0.25 sq. in. (Bottom) + 3 Via Pads	115.4	113.9
1 Layer = 0.5 sq. in. (Bottom) + 3 Via Pads	105.4	104.7
1 Layer = 1.0 sq. in. (Bottom) + 3 Via Pads	100.5	100.2
2 Layer = 0.5 sq. in. (Top)/ 0.5 sq. in. (Bottom) + 33 Via Pads	93.7	92.5
2 Layer = 1.0 sq. in. (Top)/ 1.0 sq. in. (Bottom) + 53 Via Pads	82.7	82.2

ERROR FLAG OPERATION

The LMH6321 provides an open collector output at the EF pin that produces a low voltage when the Thermal Shutdown Protection is engaged, due to a fault condition. Under normal operation, the Error Flag pin is pulled up to V^+ by an external resistor. When a fault occurs, the EF pin drops to a low voltage and then returns to V^+ when the fault disappears. This voltage change can be used as a diagnostic signal to alert a microprocessor of a system fault condition. If the function is not used, the EF pin can be either tied to ground or left open. If this function is used, a 10 k Ω , or larger, pull-up resistor (R_2 in [Figure 52](#)) is recommended. The larger the resistor the lower the voltage will be at this pin under thermal shutdown. [Table 3](#) shows some typical values of V_{EF} for 10 k Ω and 100 k Ω .

Table 3. V_{EF} vs. R_2

R_2 (in Figure 52)	@ $V^+ = 5V$	@ $V^+ = 15V$
10 k Ω	0.24V	0.55V
100 k Ω	0.036V	0.072V

SINGLE SUPPLY OPERATION

If dual supplies are used, then the GND pin can be connected to a hard ground (0V) (as shown in [Figure 52](#)). However, if only a single supply is used, this pin must be set to a voltage of one V_{BE} (~0.7V) or greater, or more commonly, mid rail, by a stiff, low impedance source. This precludes applying a resistive voltage divider to the GND pin for this purpose. [Figure 56](#) shows one way that this can be done.

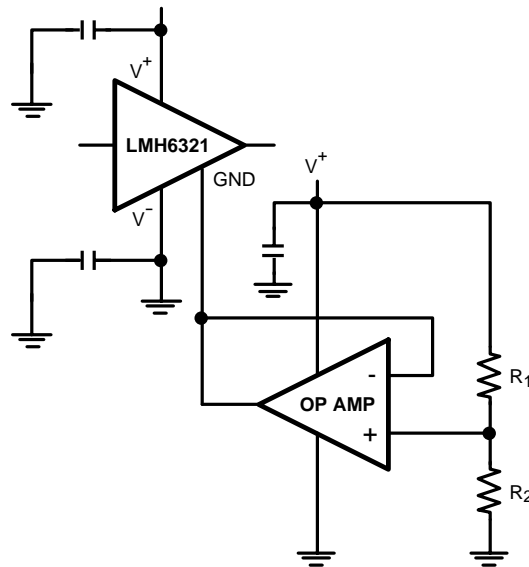

Figure 56. Using an Op Amp to Bias the GND Pin to $\frac{1}{2} V^+$ for Single Supply Operation

In [Figure 56](#), the op amp circuit pre-biases the GND pin of the buffer for single supply operation.

The GND pin can be driven by an op amp configured as a constant voltage source, with the output voltage set by the resistor voltage divider, R_1 and R_2 . It is recommended that These resistors be chosen so as to set the GND pin to $V^+/2$, for maximum common mode range.

SLEW RATE

Slew rate is the rate of change of output voltage for large-signal step input changes. For resistive load, slew rate is limited by internal circuit capacitance and operating current (in general, the higher the operating current for a given internal capacitance, the faster is the slew rate). [Figure 57](#) shows the slew capabilities of the LMH6321 under large signal input conditions, using a resistive load.

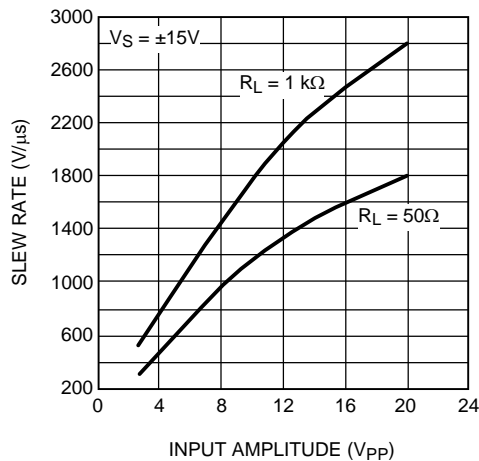

Figure 57. Slew Rate vs. Peak-to-Peak Input Voltage

However, when driving capacitive loads, the slew rate may be limited by the available peak output current according to the following expression.

$$dv/dt = I_{PK}/C_L \quad (10)$$

and rapidly changing output voltages will require large output load currents. For example if the part is required to slew at 1000 V/μs with a load capacitance of 1 nF the current demand from the LMH6321 would be 1A. Therefore, fast slew rate is incompatible with large C_L. Also, since C_L is in parallel with the load, the peak current available to the load decreases as C_L increases.

Figure 58 illustrates the effect of the load capacitance on slew rate. Slew rate tests are specified for resistive loads and/or very small capacitive loads, otherwise the slew rate test would be a measure of the available output current. For the highest slew rate, it is obvious that stray load capacitance should be minimized. Peak output current should be kept below 500 mA. This translates to a maximum stray capacitance of 500 pF for a slew rate of 1000 V/μs.

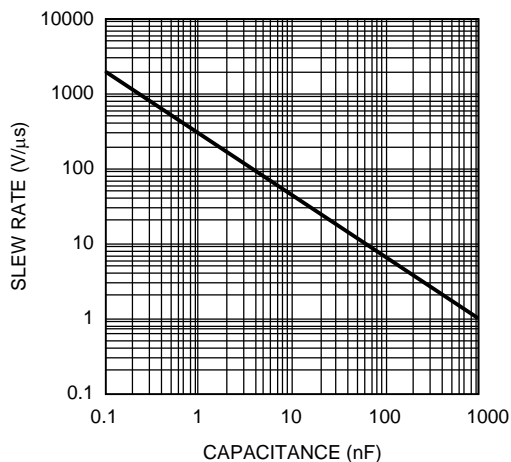

Figure 58. Slew Rate vs. Load Capacitance

REVISION HISTORY

Changes from Revision B (March 2013) to Revision C	Page
• Changed layout of National Data Sheet to TI format	23

PACKAGING INFORMATION

Orderable Device	Status (1)	Package Type	Package Drawing	Pins	Package Qty	Eco Plan (2)	Lead/Ball Finish (6)	MSL Peak Temp (3)	Op Temp (°C)	Device Marking (4/5)	Samples
LMH6321MR	NRND	SO PowerPAD	DDA	8	95	TBD	Call TI	Call TI	-40 to 125	LMH63 21MR	
LMH6321MR/NOPB	ACTIVE	SO PowerPAD	DDA	8	95	Green (RoHS & no Sb/Br)	CU SN	Level-3-260C-168 HR	-40 to 125	LMH63 21MR	Samples
LMH6321MRX/NOPB	ACTIVE	SO PowerPAD	DDA	8	2500	Green (RoHS & no Sb/Br)	CU SN	Level-3-260C-168 HR	-40 to 125	LMH63 21MR	Samples
LMH6321TS	NRND	DDPAK/ TO-263	KTW	7	45	TBD	Call TI	Call TI	-40 to 125	LMH6321TS	
LMH6321TS/NOPB	ACTIVE	DDPAK/ TO-263	KTW	7	45	Pb-Free (RoHS Exempt)	CU SN	Level-3-245C-168 HR	-40 to 125	LMH6321TS	Samples
LMH6321TSX/NOPB	ACTIVE	DDPAK/ TO-263	KTW	7	500	Pb-Free (RoHS Exempt)	CU SN	Level-3-245C-168 HR	-40 to 125	LMH6321TS	Samples

(1) The marketing status values are defined as follows:

ACTIVE: Product device recommended for new designs.

LIFEBUY: TI has announced that the device will be discontinued, and a lifetime-buy period is in effect.

NRND: Not recommended for new designs. Device is in production to support existing customers, but TI does not recommend using this part in a new design.

PREVIEW: Device has been announced but is not in production. Samples may or may not be available.

OBSELETE: TI has discontinued the production of the device.

(2) Eco Plan - The planned eco-friendly classification: Pb-Free (RoHS), Pb-Free (RoHS Exempt), or Green (RoHS & no Sb/Br) - please check <http://www.ti.com/productcontent> for the latest availability information and additional product content details.

TBD: The Pb-Free/Green conversion plan has not been defined.

Pb-Free (RoHS): TI's terms "Lead-Free" or "Pb-Free" mean semiconductor products that are compatible with the current RoHS requirements for all 6 substances, including the requirement that lead not exceed 0.1% by weight in homogeneous materials. Where designed to be soldered at high temperatures, TI Pb-Free products are suitable for use in specified lead-free processes.

Pb-Free (RoHS Exempt): This component has a RoHS exemption for either 1) lead-based flip-chip solder bumps used between the die and package, or 2) lead-based die adhesive used between the die and leadframe. The component is otherwise considered Pb-Free (RoHS compatible) as defined above.

Green (RoHS & no Sb/Br): TI defines "Green" to mean Pb-Free (RoHS compatible), and free of Bromine (Br) and Antimony (Sb) based flame retardants (Br or Sb do not exceed 0.1% by weight in homogeneous material)

(3) MSL, Peak Temp. - The Moisture Sensitivity Level rating according to the JEDEC industry standard classifications, and peak solder temperature.

(4) There may be additional marking, which relates to the logo, the lot trace code information, or the environmental category on the device.

(5) Multiple Device Markings will be inside parentheses. Only one Device Marking contained in parentheses and separated by a "~" will appear on a device. If a line is indented then it is a continuation of the previous line and the two combined represent the entire Device Marking for that device.

⁽⁶⁾ Lead/Ball Finish - Orderable Devices may have multiple material finish options. Finish options are separated by a vertical ruled line. Lead/Ball Finish values may wrap to two lines if the finish value exceeds the maximum column width.

Important Information and Disclaimer: The information provided on this page represents TI's knowledge and belief as of the date that it is provided. TI bases its knowledge and belief on information provided by third parties, and makes no representation or warranty as to the accuracy of such information. Efforts are underway to better integrate information from third parties. TI has taken and continues to take reasonable steps to provide representative and accurate information but may not have conducted destructive testing or chemical analysis on incoming materials and chemicals. TI and TI suppliers consider certain information to be proprietary, and thus CAS numbers and other limited information may not be available for release.

In no event shall TI's liability arising out of such information exceed the total purchase price of the TI part(s) at issue in this document sold by TI to Customer on an annual basis.

TAPE AND REEL INFORMATION

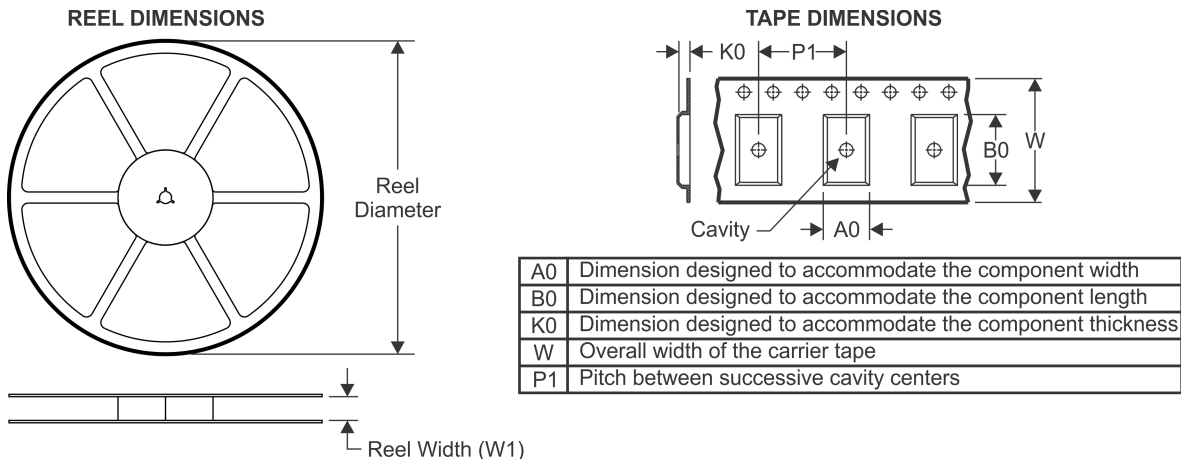

QUADRANT ASSIGNMENTS FOR PIN 1 ORIENTATION IN TAPE



*All dimensions are nominal

Device	Package Type	Package Drawing	Pins	SPQ	Reel Diameter (mm)	Reel Width W1 (mm)	A0 (mm)	B0 (mm)	K0 (mm)	P1 (mm)	W (mm)	Pin1 Quadrant
LMH6321MRX/NOPB	SO Power PAD	DDA	8	2500	330.0	12.4	6.5	5.4	2.0	8.0	12.0	Q1
LMH6321TSX/NOPB	DDPAK/TO-263	KTW	7	500	330.0	24.4	10.75	14.85	5.0	16.0	24.0	Q2

TAPE AND REEL BOX DIMENSIONS



*All dimensions are nominal

Device	Package Type	Package Drawing	Pins	SPQ	Length (mm)	Width (mm)	Height (mm)
LMH6321MRX/NOPB	SO PowerPAD	DDA	8	2500	367.0	367.0	35.0
LMH6321TSX/NOPB	DDPAK/TO-263	KTW	7	500	367.0	367.0	45.0

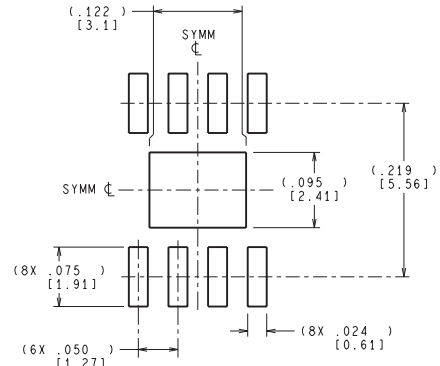
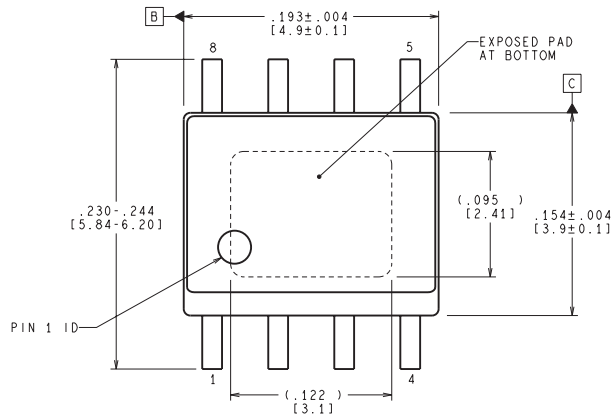
DDA0008B

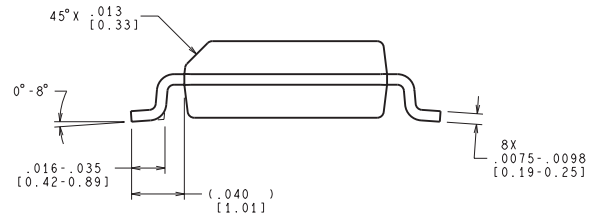
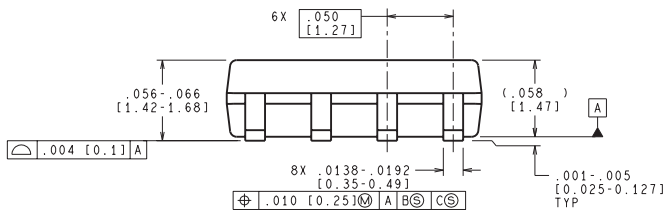

RECOMMENDED LAND PATTERN



CONTROLLING DIMENSION IS INCH
 VALUES IN [] ARE MILLIMETERS
 DIMENSIONS IN () FOR REFERENCE ONLY

MRA08B (Rev B)

KTW0007B

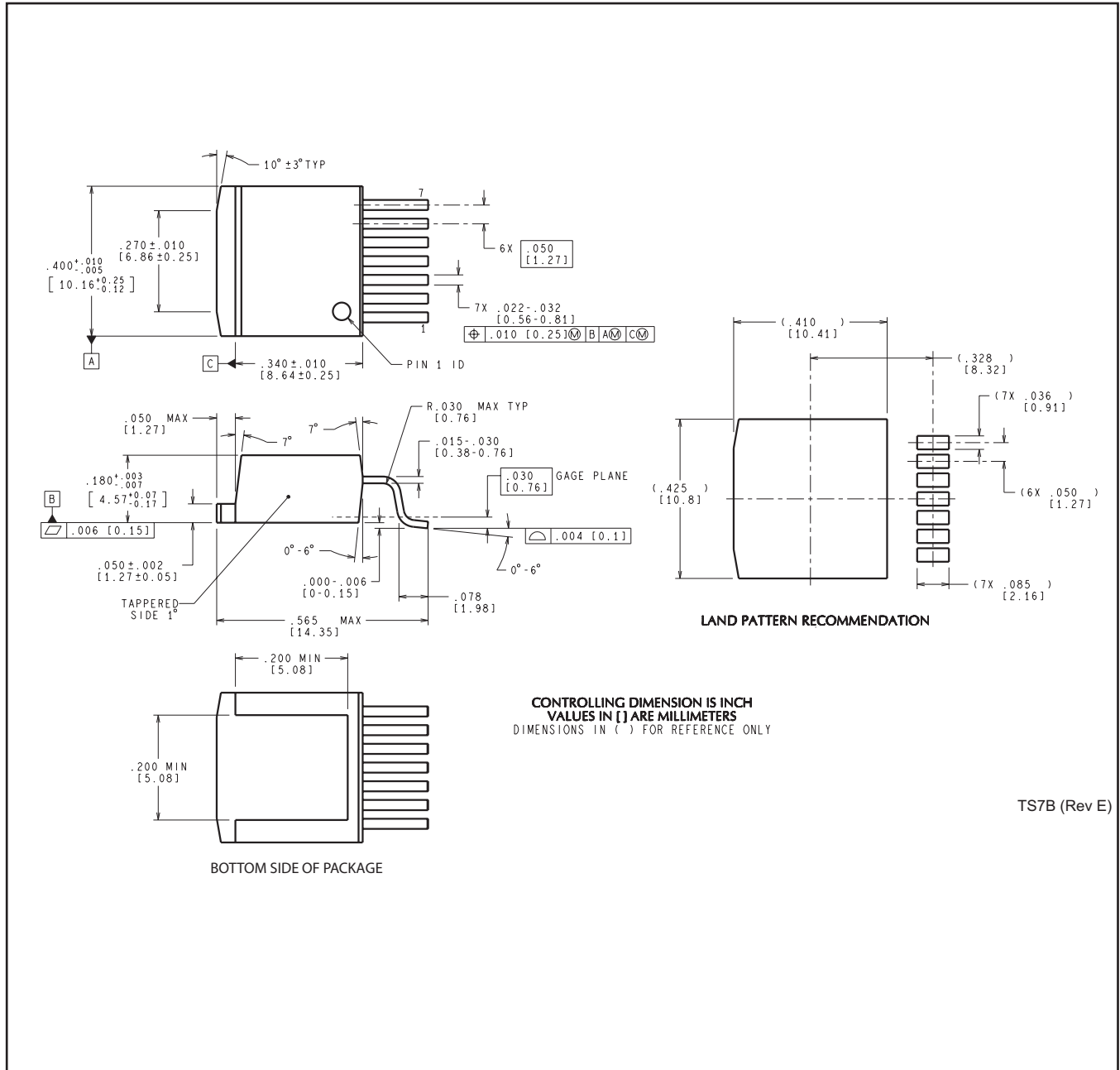

TS7B (Rev E)

IMPORTANT NOTICE

Texas Instruments Incorporated and its subsidiaries (TI) reserve the right to make corrections, enhancements, improvements and other changes to its semiconductor products and services per JESD46, latest issue, and to discontinue any product or service per JESD48, latest issue. Buyers should obtain the latest relevant information before placing orders and should verify that such information is current and complete. All semiconductor products (also referred to herein as "components") are sold subject to TI's terms and conditions of sale supplied at the time of order acknowledgment.

TI warrants performance of its components to the specifications applicable at the time of sale, in accordance with the warranty in TI's terms and conditions of sale of semiconductor products. Testing and other quality control techniques are used to the extent TI deems necessary to support this warranty. Except where mandated by applicable law, testing of all parameters of each component is not necessarily performed.

TI assumes no liability for applications assistance or the design of Buyers' products. Buyers are responsible for their products and applications using TI components. To minimize the risks associated with Buyers' products and applications, Buyers should provide adequate design and operating safeguards.

TI does not warrant or represent that any license, either express or implied, is granted under any patent right, copyright, mask work right, or other intellectual property right relating to any combination, machine, or process in which TI components or services are used. Information published by TI regarding third-party products or services does not constitute a license to use such products or services or a warranty or endorsement thereof. Use of such information may require a license from a third party under the patents or other intellectual property of the third party, or a license from TI under the patents or other intellectual property of TI.

Reproduction of significant portions of TI information in TI data books or data sheets is permissible only if reproduction is without alteration and is accompanied by all associated warranties, conditions, limitations, and notices. TI is not responsible or liable for such altered documentation. Information of third parties may be subject to additional restrictions.

Resale of TI components or services with statements different from or beyond the parameters stated by TI for that component or service voids all express and any implied warranties for the associated TI component or service and is an unfair and deceptive business practice. TI is not responsible or liable for any such statements.

Buyer acknowledges and agrees that it is solely responsible for compliance with all legal, regulatory and safety-related requirements concerning its products, and any use of TI components in its applications, notwithstanding any applications-related information or support that may be provided by TI. Buyer represents and agrees that it has all the necessary expertise to create and implement safeguards which anticipate dangerous consequences of failures, monitor failures and their consequences, lessen the likelihood of failures that might cause harm and take appropriate remedial actions. Buyer will fully indemnify TI and its representatives against any damages arising out of the use of any TI components in safety-critical applications.

In some cases, TI components may be promoted specifically to facilitate safety-related applications. With such components, TI's goal is to help enable customers to design and create their own end-product solutions that meet applicable functional safety standards and requirements. Nonetheless, such components are subject to these terms.

No TI components are authorized for use in FDA Class III (or similar life-critical medical equipment) unless authorized officers of the parties have executed a special agreement specifically governing such use.

Only those TI components which TI has specifically designated as military grade or "enhanced plastic" are designed and intended for use in military/aerospace applications or environments. Buyer acknowledges and agrees that any military or aerospace use of TI components which have **not** been so designated is solely at the Buyer's risk, and that Buyer is solely responsible for compliance with all legal and regulatory requirements in connection with such use.

TI has specifically designated certain components as meeting ISO/TS16949 requirements, mainly for automotive use. In any case of use of non-designated products, TI will not be responsible for any failure to meet ISO/TS16949.

Products

Audio	www.ti.com/audio
Amplifiers	amplifier.ti.com
Data Converters	dataconverter.ti.com
DLP® Products	www.dlp.com
DSP	dsp.ti.com
Clocks and Timers	www.ti.com/clocks
Interface	interface.ti.com
Logic	logic.ti.com
Power Mgmt	power.ti.com
Microcontrollers	microcontroller.ti.com
RFID	www.ti-rfid.com
OMAP Applications Processors	www.ti.com/omap
Wireless Connectivity	www.ti.com/wirelessconnectivity

Applications

Automotive and Transportation	www.ti.com/automotive
Communications and Telecom	www.ti.com/communications
Computers and Peripherals	www.ti.com/computers
Consumer Electronics	www.ti.com/consumer-apps
Energy and Lighting	www.ti.com/energy
Industrial	www.ti.com/industrial
Medical	www.ti.com/medical
Security	www.ti.com/security
Space, Avionics and Defense	www.ti.com/space-avionics-defense
Video and Imaging	www.ti.com/video

TI E2E Community

e2e.ti.com

Mouser Electronics

Authorized Distributor

Click to View Pricing, Inventory, Delivery & Lifecycle Information:

[Texas Instruments:](#)

[LMH6321MR](#) [LMH6321MR/NOPB](#) [LMH6321MRX/NOPB](#) [LMH6321TS](#) [LMH6321TS/NOPB](#) [LMH6321TSX/NOPB](#)